

Apparent Mass of Small Children: Experimental Measurements

J. Giacomini

Department of Mechanical Engineering

The University of Sheffield

Mappin Street, Sheffield S1 3JD

Tel: 0114-222-7781 Fax: 0114-222-7890

e-mail: j.a.giacomini@sheffield.ac.uk

Summary

A test facility and protocol were developed for measuring the seated, vertical, whole-body vibration response of small children of less than 18 kg in mass over the frequency range from 1 to 45 Hz. The facility and protocol adhered to the human vibration testing guidelines of BS7085 and to current codes of ethics for research involving children. Additional procedures were also developed which are not currently defined in the guidelines, including the integral involvement of the parents and steps taken to maximise child happiness. Eight children were tested at amplitudes of 0.8 and 1.2 m/s² using band-limited, Gaussian, white noise acceleration signals defined over the frequency interval from 1 to 50 Hz. Driving point apparent mass modulus and phase curves were determined for all eight children at both test amplitudes. All results presented a single, principal, anti-resonance, and were similar to data reported for primates and for adult humans seated in an automotive posture which provided backrest support. The mean frequency of the apparent mass peak was 6.25 Hz for the small children, as compared to values from 6.5 to 8.5 Hz for small primates and values from 6.5 to 8.6 Hz for adults seated with backrest support. The peak value of the mean, normalised, apparent mass was 1.54 for the children, which compares to values from 1.19 to 1.45 reported in the literature for small primates and 1.28 for adults seated with backrest support. ISO standard 5982, which specifies a mean, normalised, apparent mass modulus peak of 1.50 at a frequency of 4.0 Hz for adults seated without backrest support, provides significant differences.

Keywords: children, vibration, mass, child seat, vehicle

1. Introduction

Over the past 60 years the whole-body vibration response characteristics of adult humans has been widely investigated and reported (Dupuis and Zerlett 1986; Griffin 1990). From the time of the earliest studies driving point measurements of mechanical impedance have been performed along various vibration axis. Influential studies include those of Von Bekèsy (1939), Dieckmann (1957), Coermann (1961 and 1962), Vogt et. al. (1968), Vykukal (1968), Miwa (1975), Holmlund and Lunström (1998) and Holmlund et. al. (2000). Numerous independent parameters affecting the human driving point response have been investigated including body posture (Miwa 1975), gender (Holmlund and Lunström 1998; Holmlund et. al. 2000), increased gravity loadings (Vogt 1968; Vykukal 1968) and high dynamic loadings from impacts (Wittmann and Phillips 1969).

A 1978 study by Sandover suggested the potential superiority of apparent mass measurements with respect to impedance measurements when investigating whole-body vibration response. Since then numerous studies have reported driving point apparent mass for the adult human body including those of Fairley and Griffin (1989 and 1990), Mansfield and Lunström (1999), Mansfield and Griffin (2000) and Rakheja et. al. (2002). As with mechanical impedance, the apparent mass has been determined for a range of postures including sitting postures similar to those adopted in vehicles (Boileau and Rakheja 1998; Rakheja et. al. 2002). A variety of vibration conditions have also been tested including shock exposures (Mansfield et. al. 2001).

In the case of the whole-body response of seated adults several generalisations can be made. Inter-subject variability has normally been found to be the most important independent source of variability, leading most studies to be performed using test groups of at least 6 to 15 subjects. Intra-subject variability has been found to be smaller, with reports of variations of less than +/- 10% in the apparent mass over the frequency range from 1 to 20 Hz (Fairley and Griffin 1989). Most studies of driving point response have been performed over the frequency range from 0 to 20 Hz, and have used r.m.s. acceleration amplitudes in the range from 0.25 to 2 m/s². Driving point measurements of impedance or apparent mass for seated adults in the vertical direction have normally shown a large characteristic peak (an anti-resonance point where the input force reaches a maximum for a given fixed input motion) in the region from 4 to 6 Hz and often a second, smaller, peak in the region from 8 to 15 Hz. The damping ratio associated with these peaks has been found to be high, typically in the range from 0.25 to 0.6. One review of the literature relative to adults seated without backrest support (Boileau et. al. 1998) suggested a mean mass-normalised vertical apparent mass peak

value of approximately 1.15. A study performed instead for adults seated in a driving posture with backrest support (Rakheja et. al. 2002) has reported anti-resonance peaks in the range from 6.5 to 8.6 Hz, with a mean mass normalised apparent mass modulus in the range from 1.0 to 1.3. From the driving point characteristics, linear mass-spring-damper models with 1 to 4 degrees of freedom have commonly been chosen to represent the body response.

In the case of whole-body response of seated adults without backrest support the knowledge has been sufficient to specify mean impedance and apparent mass characteristics in standards. In 1981 the International Standards Organisation published Standard 5982 "Vibration and shock – Mechanical driving point impedance of the human body". It was intended as a summary of the then existing literature of the driving point mechanical impedance data measured for the adult human body in the vertical direction for the seated, standing and supine postures. It provided both tabulated values and mass-spring-damper analytical representations. 2001 saw the publication of a revised edition of standard 5982 titled "Mechanical vibration and shock – range of idealised values to characterise seated-body biodynamic response under vertical vibration". The revision presented numerous improvements including a more detailed specification of the sitting postures and vibration conditions considered, the use of both impedance and apparent mass representations, and revised mechanical models. These standards have been widely applied in the design of vehicles and of vehicle seats.

A highly specialised seating system which has grown in importance in recent years is the child safety seat. Vibrational measurements for child seats were first reported by Giacomini (2000) who measured the accelerations at the interface between child and child seat for two stage 0&1 devices within the operational environment of one vehicle when driving over two road surfaces. A further study (Giacomini and Gallo 2003) presented the results of measurements performed for eight combinations of child, stage 0&1 child seat and vehicle when driving over one road surface at two speeds. The same author also performed an experimental modal analysis (Ewins 1984; Maia and Silva 1997) of two representative stage 0&1 child seats to determine their vibrational properties (Giacomini 1997a). Having measured the modal and operational properties of representative systems, a detailed knowledge of child whole-body vibration response was necessary to complete the understanding of the mechanically coupled system consisting of vehicle seat, stage 0&1 child seat and child.

In the human whole-body vibration literature the youngest test subjects previously reported were a group of twelve children with ages ranging from 7 to 14 years who were tested by Fairley and Griffin (1989) and modelled analytically by Wei and Griffin (1998). The ages and sizes of these children were not, however, appropriate to stage 0&1 child seats. Information was therefore sought in the literature relative to small primates whose size better approximated that of children. A 1971 study by Broderson and Von Gierke described an apparatus for measuring the driving point mechanical impedance of Rhesus monkeys (*Macaca mulatta*) and presented data for two subjects of 6.6 and 7.7 kilograms in mass. The impedance curves for both animals were found to be similar to those of humans, having a peak in the region from 6 to 8 Hz. The same authors developed a two-mass, single degree of freedom, linear mass-spring-damper model of their 6.6 kg subject to represent its driving point response. In 1976 Edwards et. al. presented impedance data from tests of six Rhesus monkeys and eighteen dogs in sitting postures. The tests were performed using sinusoidal excitation in the range from 2 to 30 Hz and a two-mass single degree of freedom model was established for each animal. Slonim (1985) presented seated vertical impedance curves for four Rhesus monkeys and three baboons showing mean frequencies of peak impedance at 8, 20 and 35 Hz for the monkeys and 7, 18 and 40 Hz for the Baboons. Smith (1992 and 1994) has also reported impedance data for a total of seven Rhesus monkeys and has fit both single and dual degree of freedom linear mass-spring-damper models to the response data of several of the primates. In generalising the findings for the vertical vibration response of primates seated with backrest support, it can be stated that a large characteristic impedance peak has been found at frequencies varying from 5 Hz to 10 Hz with a tendency towards the higher values. A second impedance peak has occasionally been identified in the interval from 8 to 20 Hz, again with a tendency towards the higher values. The damping ratios of mass-spring-damper models fit to the impedance data have been in the range from 0.15 to 0.45. Both single and dual degree of freedom, two-mass, mass-spring-damper models have been established for primates with the majority of the studies opting for a single degree of freedom representation.

Comparison of the whole-body vibration literature for adult humans and for small primates suggests that similarities exist in the damping properties, in the number of degrees of freedom and in the analytical models adopted. The largest difference has been the value of the highly influential parameter of the frequency of peak response, which has sometimes been found to be higher in primates than in adult humans. Since the frequencies of peak response did not always coincide, and since no reports of the vibration properties of children of age 0 to 4 years and weight 1 to 18 kg appropriate to stage 0&1 child seats were found, measurements of small children were deemed

necessary. A first attempt was the development of a device (Giacomin 1997b) for measuring, within the vehicle operating environment, the vertical apparent mass of a small child seated with backrest support. Preliminary measurements performed using the device suggested that the child response might be different from that of adults, but the uncontrolled vibrational input typical of in-vehicle measurements (Holmlund 1999; Holmlund and Lundström 2001) limited the possibilities of producing conclusive evidence. This paper describes instead a test facility and protocol developed for the purpose of performing, in a safe and friendly environment, seated whole-body vibration measurements of small children under 18 kg in mass. Also presented are the apparent mass results obtained for eight children over the frequency range from 1 to 45 Hz.

2. Child Vibration Testing Facility

2.1 Choice of Vibration Exciter, Control System and Sensors

The choice of vibration exciter and control system was made with the primary objective of providing a safe and ethically acceptable test environment. British Standard 7085 (1989) identifies two primary risk factors in human testing (a) use of mechanical vibration or shock that is too severe in terms of magnitude or duration and (b) failure to exclude from testing a subject who is medically unfit. Minimisation of the risks inherent in point (a) suggested the use of the smallest possible excitation system capable of imparting to a child of mass in the expected range from 2 to 18 kilograms a vibration similar to what occurs in vehicles. A Ling Dynamic Systems (LDS) V406 permanent magnet shaker and PA100E electronic power amplifier were chosen. The unit was rated at a maximum peak sine force of 98 N and a maximum random force (measured in accordance to ISO5344) of 38 N. With the expectation that the combined moving mass of the system (test subject, rigid seat, vibration platform, bearings, shaker coil and sensors) would be no less than 20 kg, the V406 would be incapable of imparting accelerations greater than 5 m/s^2 to the child.

Also specified in BS7085 are recommended characteristics for human testing control systems. A three level control strategy is suggested in which an *input monitor* maintains the calculated control signals within specified movement or force values, a *platen motion monitor* maintains hardware motion or force within pre-established limits independently of controller output, and a *system monitor* continuously assesses the state of the various components. In order to match the safety functions of the three monitors the vibration control system chosen was the Endurance Monitor

(EMON) software system (LMS International 1999) coupled to a DIFA SCADASII electronic frontend unit. The EMON software permitted the setting of numerical limits on the test force and acceleration in accordance with the *input monitor* principle. These limits were set to 2.0 m/s^2 peak acceleration and 100 N peak transmitted force. The principle of *platen motion monitor* was fulfilled by the use of a DIFA SCADAS Shutdown Control Unit which incorporated both a manual emergency shutdown button and an emergency soft-stop condenser circuit for bringing the exciter to rest in the case of power or sensor failures. The principle of *system monitor* was fulfilled by the use of the PA100E electronic power amplifier which incorporated a core overheating and an overvoltage interrupt.

Acceleration was measured by means of an ENTRAN EGAS-FT-25 accelerometer fixed to the lower surface of a rigid seat. The maximum acceleration rating of the sensor was 25 g, it had a sensitivity of 3.66 mV/g with 15 volts supply and had a natural frequency of 730 Hz. As in the work of Coermann (1961) the force transmitted to the rigid seat was measured by means of three sensors placed at the apexes of a triangle. The three load cells were ENTRAN type ELH-TC11-500s rated as linear to 500 N and having sensitivities of 0.16 mV/N with 15 volts supply. Figure 1 presents a schematic diagram of the test facility.

[INSERT FIGURE 1 HERE]

2.2 Vibration Platform and Suspension System Design

By their physical nature electrodynamic exciters such as the V406 are unable to maintain constant forces. These devices therefore often incorporate an internal spring to maintain the moving coil in its neutral position under gravity loading. The internal spring of the V406 was insufficient, however, to maintain positioning under the loading of the rigid seat and test subject. A platform and an external suspension system were therefore required, whose design was performed with two primary objectives in mind: (1) that the platform area be sufficiently large to avoid the child reaching with hands or feet any bench components when sitting restrained and (2) that the moving mass be sufficiently small to permit the shaker to achieve the target test accelerations. The first objective was the overriding concern since it was central towards achieving a test characterised by “not greater than minimum risk”. “Not greater than minimum risk” is a cornerstone of current ethical guidelines, with origin dating from the time of the Nuremberg code (summarised in Grodin and Glatntz 1994) and full expression by the time of the U.S. Department of Health and Human Services research guidelines first published in 1973 (Department of Health, Education and Welfare 1973).

An aluminium platform assembly was designed which was 760 mm long by 405 mm wide. The linear bearings chosen had friction coefficients between 0.002 and 0.003 and yaw and pitch moment capacity of 125 Nm. Bearing preloading was achieved by means of a sliding wedge block mounted on one side of the platform. Static load support was achieved by means of linear springs connecting the vibrating platform to support towers. The number and the deflected length of the linear springs was made adjustable to accommodate changes in test load. Provision was made for a maximum of 16 equal springs whose deflected length could be adjusted by means of screws and washers. Each had an undeflected length of 290mm and stiffness of 90 N/mm. Stiffness adjustment permitted the natural frequency of the platform system to be kept below 1 Hz, avoiding the frequency range of the intended measurements.

2.3 Rigid Seat Design

The geometry of the rigid seat was determined based on child anthropometric data and geometric data from commercial child safety seats. For children of 9 to 11 months of age Tilley (1993) suggests an average total length of the supine body of 730 mm, an average buttock-to-head distance of 480 mm and a total width (inter-acromion distance) of 208 mm. For commercial child seats four parameters (see Figure 2) were chosen to define the sitting posture: lower section length (L_1), backrest section length (L_2), included angle between the two sections (F) and the seat angle with respect to the horizontal (T) when placed on a flat horizontal surface. Table 1 presents the seat geometric parameters for two child seats which were found to be representative of a class of similar stage 0&1 designs found in stores.

[INSERT FIGURE 2 HERE] [INSERT TABLE 1 HERE]

Based on the child and child seat dimensions a sitting basket was designed which had a lower section length (L_1) of 300 mm, a backrest section length (L_2) of 450 mm and a width of 280 mm. An included angle F of 90 degrees and an angle of 20 degrees with respect to the horizontal (T) were chosen. The basket was fabricated of 1.5 mm thick aluminium sheet which was cut to pattern, bent and welded at points along the joining lines. A base section to support the basket and to provide a mounting surface for the sensors was machined out of aluminium. The base section was 146 mm long, 65 mm at its highest point and 280 mm wide. The basket and base were welded together to form a single unit and lateral drilling into the base section was used to remove material until a mass

of 3.0 kilograms was achieved. The first natural frequency of the complete unit was greater than 170 Hz.

In line with the guidelines of BS7085 and in order to minimise child movement during testing, the rigid seat was equipped with restraining belts from a Mothercare Rock 'n' Go child seat. Mounting holes of the same size as in the commercial product were perforated into the lower and upper sections of the rigid seat at the same locations. The belts were fastened in the same manner by passing them through the holes and by blocking them from behind using the plastic clips moulded into the terminus of each belt.

2.4 Choice of Acceleration Test Signals

The principle of “not greater than minimum risk” suggests that human vibration testing protocols should minimise the total exposure. BS 7085 specifies that vibration exposure should be measured in terms of the *Vibration Dose Value (VDV)*

$$VDV = \left[\int_0^T a^4(t) dt \right]^{1/4} \quad (1)$$

where $a(t)$ is the frequency weighted acceleration in m/s^2 and T is the period of exposure in seconds. The frequency weighting used to summarise the possibly damaging effects of vibration on the human body varies with point and direction of input. BS7085 suggests the use of frequency weighting curve W_b when quantifying the effects of vertical direction vibration input to the buttocks through the seat. BS7085 specifies a W_b frequency weighted VDV value of $15 m/s^{1.75}$ as the limiting exposure which should not normally be exceeded except in the special case of studies at high dynamic rates in which case a medical officer should be present.

Vibration Dose Values have been reported for road vehicles by several researchers. A particularly large study was performed by Paddan and Griffin (2002) who presented frequency weighted acceleration values measured at the seat of 100 vehicles over characteristic, but unspecified, road surfaces. Among the vehicles were 25 automobiles. The vertical W_b weighted acceleration was reported for the seat cushion interface with the driver in the vertical direction. The measurements for automobiles spanned a range from 0.25 to 0.61 m/s^2 weighted r.m.s., with a median value of 0.37.

The corresponding VDV values for a 2 minute exposure were from 1.16 to 2.82 with a median value of $1.71 \text{ m/s}^{1.75}$, suggesting that vertical vibration at the seat cushion of road vehicles is a factor of 9 lower, on average, than the BS 7085 limit.

Considering the need to lower the total test exposure, a band-limited Gaussian random excitation was chosen. The band-limited Gaussian white noise acceleration signal was defined over the interval from 1 to 50 Hz using a sampling rate of 200 Hz. Preliminary testing showed that the unweighted input r.m.s. acceleration at the platform needed to be greater than 0.6 m/s^2 to overcome friction in the bearings and to provide a good signal-to-noise ratio. Two drive signals were therefore chosen which had r.m.s. voltage levels of 1400 and 1800 mV corresponding to actuated r.m.s. acceleration levels of 0.8 and 1.2 m/s^2 at the platform and seat. Applying W_b frequency weighting to the platform acceleration resulted in weighted r.m.s. values of 0.52 m/s^2 using the 1400mV signal and 0.75 m/s^2 for the 1800 mV signal. Time duration for both signals was chosen to be 2 minutes, producing VDV values of 10 and $14 \text{ m/s}^{1.75}$ respectively.

2.5 Child Test Facility Calibration

The test facility was calibrated using rigid masses in the place of the child occupant. Four steel blocks, each of length 25 cm and width 7.5 cm, were cut to various thicknesses to provide total masses of 3.8, 7.8 and 15.8 kilograms. An assembly consisting of two threaded rods and two cross members weighting a total of 0.2 kg was used to fasten the masses to the rigid seat so as to provide a pure inertial loading. Band-limited Gaussian random white noise voltage signals were input to the bench through a Finite Impulse Response Filter (FIR) filter designed to compensate the low force output of the V406 at frequencies below 20 Hz. While 1400 mV and 1800 mV drive signals were planned for the actual child tests, the calibration was performed at levels from 1000 mV to 1800 mV in steps of 200 mV. Mass loadings of 0 kg, 4 kg, 8 kg and 16 kg were used. The apparent mass modulus curves obtained for the calibration loadings contained errors of less than 2% from 2 to 35 Hz and less than 10 percent over the range from 1 to 42 Hz. The measured phase angles increased from +1 degree to a maximum of +8 degrees at 45 Hz.

2.6 Child Happiness

Although not specifically articulated in current textbooks treating children as research subjects (Grodin and Glantz 1994) or by ethical codes such as the code of practice of the American

Psychological Association (1992), the Canadian Tri-Council Policy Statement (1998) or the code of practice of the Society for Research in Child Development (described in Berk 1997), it was felt that child happiness should be maximised during testing.

Several steps were taken to maximise child happiness during their time in the laboratory and during testing. First, *parental presence* was ensured during all phases. Due to the time constraints on both the researcher and the parents it was not possible to arrange preparatory sessions in which the child and researcher developed a trust relationship. In the absence of an existing relationship between the child and the researcher it was decided that the test protocol should actively encourage the parents to participate by observing, talking and playing with the child. The parent, or parents, were involved as collaborators guaranteeing support for the child and ensuring additional monitoring of procedures.

A second aspect of the test protocol directed towards ensuring child happiness was a *familiarisation period* upon entering the laboratory which gave the child and parents time to become comfortable with the environment. This period included the interval in which the aims and methods were explained to the parents, the time taken to read and sign the consent forms and the time taken to weigh and measure the child. Additional time was taken to read to the child and to help the child play with toys that were kept on hand until the child showed visible signs of being comfortable with both the laboratory and the researcher.

A third feature of the test protocol aimed at ensuring child happiness was the availability of a range of *toys*. A cot mobile was installed and numerous figures dealing with cartoon characters familiar to children were pasted to various components of the facility and surrounding laboratory. Several toys were positioned so as to render the environment child-friendly and play was actively encouraged during all phases of the activity.

[INSERT FIGURE 3 HERE]

2.7 Child Movement

As early as 1961 Coermann demonstrated that sitting posture has a significant influence on measured driving point mechanical impedance. More recent research such as the 2002 study by Mansfield and Griffin has investigated in detail the effect of sitting posture on apparent mass, finding

changes of as much as 1 Hz in the frequency of peak response. Such findings suggest that active movement of the child, involving changes in sitting posture, should be discouraged during testing. One method of minimising child movement was the use of the safety belts which were buckled and adjusted to their normal operating tension at the start of each test session. A second method was to encourage the child to play with small toys and to have an adult read to the child from a book. Play provided an important distraction which helped limit movement to small motions of the arms and upper body. During all tests either the researcher or a parent read stories to the child.

[INSERT FIGURE 4 HERE]

[INSERT FIGURE 5 HERE]

Despite all efforts the nature of children is such that some movement during the vibration exposure was inevitable. Figure 4 presents a typical example consisting of motion of the upper body and arms. Such motions occurred during most tests. Figure 5 presents instead an example of a more significant shift in body posture with the subject leaning the upper body to the right and with one leg extended beyond the limits of the rigid seat. Postural shifts of this type were less frequent and readily identifiable in the force time histories of the three load cells. Apparent mass estimates performed using data from segments involving postural shifts showed only small differences with respect to the overall results determined for the complete 2 minute test exposure. Since no formal procedure for monitoring child posture had been incorporated into the test protocol and since the differences caused by changes in posture were found to be smaller than those caused by test signal amplitude, no further reporting of child posture is provided here.

2.8 Test Protocol

Eight children were tested whose ages ranged from 3 to 23 months with a mean value of 11.8. Their weight ranged from 5.0 to 12.4 kg with a mean value of 9.5 kg and their heights ranged from 50 to 86 cm with a mean value of 73.4 as shown in Table 2. The choice of eight individuals was a compromise between the need to produce a statistically representative sample and the ethical principle of “involving the fewest necessary subjects” (Grodin and Glantz 1994). While small in size, it was expected that the sample would produce useful conclusions if a degree of similarity was found across in the response data of the various individuals.

Each child was brought to the test facility by the consenting parent or parents who were all staff or students of Sheffield University. The test sequence, summarised in Table 3, sought to guarantee the

safety of all persons involved, to minimise the vibration exposure undergone by the child and to minimise the total amount of time that the child and parents were requested to spend in the laboratory. A full description of the research objectives, of the research methods, of the safety features of the facility and of the test sequence was provided verbally. The same information was also provided to the parents by means of an information and consent form which, upon acceptance to participate, was signed by the consenting adults on behalf of their children. In keeping with current ethical guidelines for scientific research involving children (see Grodin and Glantz for a complete review) no payments or other incentives were offered to either the parents or child and no deception was practiced regarding any aspect of the research objectives or procedures. In order to maintain rigorous control over the test sequences, vibration exposures, and interval times the complete test was automated by means of an EMON software playlist file which could be interrupted at any point by means of operator manual override. In keeping with the ethical principle of supporting the autonomy of the child participants and of assuming the children to be capable of a minimal competency towards determining their consent to participate, the test protocol was terminated whenever a child demonstrated unhappiness with, or fear of, the test environment. Over the course of the research activity one child subject showed signs of unhappiness, leading to the termination of the planned testing and the need to seek an additional participant. The full test protocol was externally reviewed and found to meet the University of Sheffield guidelines for good research practice.

[INSERT TABLE 2 HERE]

[INSERT TABLE 3 HERE]

3. Measured Apparent Mass Curves of Small Children

The driving point frequency response function chosen for representing the dynamic properties of small children was the apparent mass defined as

$$\text{Apparent Mass}(j\omega) = AM(j\omega) = \frac{F(j\omega)}{\ddot{x}(j\omega)} \quad (2)$$

where $F(j\omega)$ and $\ddot{x}(j\omega)$ are the Fourier Transforms of the force and acceleration, respectively, measured at the rigid seat. The apparent mass was chosen over other representations due to the ease of interpretation since the modulus approaches the static mass of the subject as frequency approaches zero. Apparent mass functions were estimated for each child using the experimentally

acquired force and acceleration time histories. The estimate was calculated by means of the H_v vector average spectral estimator which assumes random measurement error on both the input and output signals. The H_v estimator is defined (McConnell 1995) as

$$|H_v(\omega)|^2 = \frac{G_{yy}(\omega)}{G_{xx}(\omega)} \quad (3)$$

The H_v estimator was applied to the acceleration and force time histories sampled at 200 Hz. A data block size of 512 points and an overlap of 97% were used leading to a spectral resolution of 0.39 Hz. For the given processing parameters each 2 minute exposure produced a total of 1541 averages. The large number of averages was considered prudent given the possible nonlinearities in the vibration response. A Hanning window was used and all results were plotted as power spectral densities. The 3.0 kg mass loading of the rigid seat was removed from all apparent mass results by direct subtraction from the real part of the complex measure.

Figures 6 and 7 present the vertical direction apparent mass modulus and phase curves determined for each of the eight children at the r.m.s. test amplitudes of 0.8 and 1.2 m/s² (1400 and 1800 mV). For the input signal type used, the response of the child body was found to be relatively linear, as evidenced by the similarity of the responses obtained from the two different input amplitudes. For all test subjects except the largest child (subject sa) the experimentally estimated apparent mass functions suggest a single response peak. In the case of subject sa, a small contribution by a second response peak can be hypothesised, but the overall size of the contribution is small. Both the modulus and phase responses showed a high level of similarity across the test group. The smallest child tested, subject ju, was characterised by both the lowest apparent mass modulus and the highest damping ratio (as evidenced by the width of the anti-resonant peak). Coherence functions for all subjects were found to be 1.0 over the frequency range from 1 to 45 Hz.

[INSERT FIGURE 6 HERE]

[INSERT FIGURE 7 HERE]

Since all test subjects exhibited a single peak, and since there was only a limited variation in the frequency of anti-resonance, averaging of the apparent mass curves was expected to provide a useful representation of the complete group. Figure 8 presents the individual apparent mass modulus curves for the eight children and the mean curve for the group for the input vibration

amplitude of 1.2 m/s^2 . The frequency of peak apparent mass modulus occurred in the interval from 5.86 to 7.42 Hz, with a mean value of 6.25 Hz. The modulus value of the peak varied from 8.40 to 20.2 kg, with a mean value of 14.8 kg.

Figure 9 compares the mean apparent mass modulus of the children to apparent mass modulus values reported in the literature for small primates and for adult humans. Primate apparent mass was determined using the single degree of freedom models reported in the three studies of Rhesus monkeys by Broderson and Von Gierke (1971), Slonim (1985) and Smith (1992). Adult apparent mass for a sitting posture without backrest support is summarised by the recent International Standards Organisation 5982:2001(E) which defines modulus and phase values for erect sitting adults of total mass in the range from 49 to 93 kg. Adult apparent mass for individuals sitting in an automotive posture with backrest support is summarised instead by the mean curve reported by Rakheja et. al. (2002).

With total masses from 6 to 9 kilograms, the primates present the lowest overall peak modulus values: 8.1, 10.9 and 7.9 kilograms, and the highest anti-resonant frequencies: 6.5, 8.0 and 8.5 Hz respectively. The children, who are slightly larger, present a higher mean modulus peak of 14.8 kg and a lower mean anti-resonance frequency of 6.25 Hz. The data for adults seated without backrest support (ISO 5982) is characterised by a modulus peak value of 75.4 kg and an anti-resonance frequency of 4.0 Hz. The data for adults seated with backrest support (Rakheja 2002), however, has a mean modulus peak of 92 kg at a frequency of 7.6 Hz. Figure 9 suggests that similar anti-resonance frequencies occur in all the cases involving a backrest support, while the unsupported posture of ISO5982 results in a lower mean frequency of anti-resonance.

[INSERT FIGURE 8 HERE]

[INSERT FIGURE 9 HERE]

Figure 10 presents the apparent mass phase angle measured for each of the eight children and the mean curve for the group. Again as in the case of the modulus, a strong similarity exists among the individual curves, therefore the mean value would appear to provide a useful representation of the group. Figure 11 compares the mean phase response for the children to those of both primates and adult humans. A degree of similarity can be noted among the various curves with the possible exception of the phase relationship of ISO 5982 for adults seated without backrest support. In this case two distinct changes in slope occur at approximately 4.5 and 12 Hz, suggesting the presence of two externally measurable anti-resonant responses.

[INSERT FIGURE 10 HERE] [INSERT FIGURE 11 HERE] [INSERT FIGURE 12 HERE]

A commonly used technique for facilitating apparent mass comparisons across humans of different size is to normalise the modulus values for a given individual by his or her static mass. Figure 12 presents the apparent mass modulus curves in mass-normalised form for the three subject groups considered: primates, small children and adults. The mass-normalised representation suggests a level of similarity between the responses of subjects who sat with the back supported by a backrest. The data of ISO 5982, for the unsupported posture, shows instead a much lower frequency of anti-resonance.

4. Discussion

The optimal design of devices such as child safety seats requires dynamic response data for small children. Since data of this type is difficult to measure in operational environments such as road vehicles, purpose-built laboratory equipment and protocols are required. An important point of reference for the development of such systems is British Standard 7085 which provides guidelines of good practice for human vibration testing. The testing of small children raises, however, important additional questions which have not all been fully addressed in BS 7085. The literature treating children as research subjects (Grodin and Glantz 1994) and the various codes of ethics such as the U.S. Department of Health and Human Services research guidelines, those of the American Psychological Association, those of the Canadian Tri-Council and those of the Society for Research in Child Development, have provided further principles of good practice. The facility and protocol developed in the current study have adhered strictly to the guidance provided by BS7085 and the current codes. Examples of compliance include the development of a test device with dimensions which were large enough to avoid possible limb entrapment, the design of a test seat which resembled actual child seats and the use of vibrations which were within recommended safe limits. Due to the delicate nature of interaction with children, several further procedures were developed which are not currently strictly defined in the international guidelines. Examples of additional child-specific features include the integral involvement of the parents in the test activity, and a series of steps (decorations, toys, playtime, etc.) taken to maximise child happiness throughout the period of the test activity.

The apparent mass curves measured for eight small children were found to be similar. The most evident variations occurred in the case of the smallest child, subject ju, whose data suggested a higher damping level than the others. All eight sets of apparent mass modulus and phase suggested a single anti-resonance. A single degree of freedom mass-spring-damper model may therefore prove an adequate representation of the body of small children in the vertical direction for the purposes of dynamic simulation of child safety seats.

The mean apparent mass modulus and phase curves measured in the vertical direction for the children were found to be similar to those of primates and those of adult humans seated in a similar posture with backrest support. The mean frequency of the apparent mass peak was 6.25 Hz for the small children, as compared to values from 6.5 to 8.5 Hz reported for Rhesus monkeys and values from 6.5 to 8.6 Hz reported for adults seated in an automotive posture with supporting backrest. ISO 5982 for adult humans seated without backrest support, on the other hand, specifies a peak in the apparent mass modulus at approximately 4.0 Hz. The frequency location of the principal, externally measurable, body response is therefore different from that of the other data sets considered. Differences are also evident between the peak normalised apparent mass modulus values of the various data sets. The normalised peak value ranges from 1.19 to 1.45 in the case of the primates, was 1.54 for the mean of the eight children tested here, is 1.28 for adults seated with backrest support (Rakheja et. al. 2002) and is approximately 1.50 for adults seated without backrest support (ISO 5982).

As a final point for consideration, frequency weightings such as the vertical direction W_b of BS 6841 or W_k of ISO 2631 have been developed based on the subjective response of adult humans. In many cases, these measurements of subjective response have been performed without backrest support. Given the difference in mean frequency of anti-resonance between the data of ISO 5982 (for unsupported sitting postures) and the other data sets considered, it remains an open question whether existing evaluation methods adequately represent the level of vibration discomfort or the health risk caused to backrest supported individuals, particularly children. Further research in this area should prove beneficial.

5. Conclusions

A facility was designed and built for measuring the whole-body vibration response properties of small children of less than 18 kg in mass over the frequency range from 1 to 45 Hz. The facility

adhered to the guidelines provided by BS7085 and the existing ethical codes of practice for research involving children. Due to the delicate nature of interaction with children, however, several further procedures were required which are not currently defined in the international guidelines. Examples of additional features include the integral involvement of the parents in the test activity and steps taken to maximise child happiness.

Eight children, of the size range appropriate to stage 0&1 child safety seats, were tested and their apparent mass modulus and phase curves determined. All curves contained a single anti-resonance, suggesting that in many cases a single degree of freedom mass-spring-damper model may prove adequate for purposes of vertical direction simulation. The mean frequency of the apparent mass peak was found to be 6.25 Hz for the children, as compared to values from 6.5 to 8.5 Hz reported for Rhesus monkeys and values from 6.5 to 8.6 Hz reported for adults seated in an automotive posture with backrest support. The normalised apparent mass peak value ranged from 1.19 to 1.45 in the case of the primates reported in the literature, was 1.54 for the mean of the eight children tested here, and has been reported to be 1.28 for adults seated with backrest support.

ISO 5982, which specifies adult apparent mass for a posture without backrest support, suggests a normalised modulus peak value of approximately 1.50, which is similar to the other data sets considered during the current study. The peak value occurs, however, at a lower frequency than in the case of the other data sets, at approximately 4.0 Hz. Given the possible correlation between human mechanical and subjective response, further research may prove useful to establish the adequacy of current methods when evaluating the whole-body vibration discomfort which occurs in backrest supported seated postures.

6. References

American Psychological Association (APA) 1992, Ethical principles of psychologists and code of conduct, *American Psychologist*, **47** (12), 1597-1611.

Berk, L.E. 1997, *Child Development, Fourth Edition* (Boston: Allyn and Bacon Publishers).

Boileau, P.E., Wu, X. and Rakheja, S. 1998, Definition of a range of idealized values to characterise seated body biodynamic response under vertical vibration, *Journal of Sound and Vibration*, **215**(4), 841-862.

Boileau, P.E. and Rakheja, S. 1998, Whole-body vertical biodynamic response characteristics of the seated vehicle driver: Measurement and model development, *International Journal of Industrial Ergonomics*, **22**, 449-472.

British Standards Institution 1987, *BS 6841 Measurement and evaluation of human exposure to whole-body vibration and repeated shock* (London: British Standards Institution).

British Standards Institution 1989, *BS 7085 Safety aspects of experiments in which people are exposed to mechanical vibration and shock* (London: British Standards Institution).

Broderson, A.B. and Von Gierke, H.E. 1971, Mechanical impedance and its variation in the restrained primate during prolonged vibration, *ASME Paper 71-WA / BHF-8*, (New York: American Society of Mechanical Engineers).

Coermann, R.R. 1961, The mechanical impedance of the human body in sitting and standing position at low frequencies, *ASD Technical Report 61-492*, (Wright-Patterson Air Force Base, Ohio: Aeronautical Systems Division).

Coermann, R.R. 1962, The mechanical impedance of the human body in sitting and standing position at low frequencies, *Human Factors*, **4**, 227-253.

Department of Health, Education and Welfare 1973, Draft working document on experimentation with children, *Federal Register*, **38** (31746).

Dieckmann, D. 1957, A study of the influence of vibration on man, *Ergonomics*, **1**, 347-355.

Dupius, H. and Zerlett, G. 1986, *The effects of whole-body vibration* (Berlin: Springer-Verlag).

Edwards, R.G., Lafferty, J.F. and Knapp, C.F. 1976, Experimental and analytical determinations of the mechanical impedance response of animals to vertical vibration, *Journal of Biomechanics*, **9**, 55-61.

Ewins, D.J. 1984, *Modal Testing: Theory and Practice* (Taunton, Somerset: Research Studies Press Ltd.).

Fairley, T.E. and Griffin, M.J. 1989, The apparent mass of the seated human body: vertical vibration, *Journal of Biomechanics*, **22** (2), 81-94.

Fairley, T.E. and Griffin, M.J. 1990, The apparent mass of seated human body in the fore-and-aft and lateral directions, *Journal of Sound and Vibration*, **139**, 299-306.

Giacomin, J. 1997a, Modal properties of child safety seats. Proceedings of the Associazione Tecnica dell'Automobile 4th International Conference on Comfort in the Automobile Industry, Bologna, Italy, 2-3 October, 415-425.

Giacomin, J. 1997b, In-vehicle measurement of the apparent mass of small children. Proceedings of the United Kingdom Group Meeting on Human Response to Vibration, ISVR, University of Southampton, United Kingdom, 17-19 September.

Giacomin, J. 2000, Some observations regarding the vibrational environment in child safety seats, *Applied Ergonomics*, **31**, 207-215.

Giacomin, J. and Gallo, S. 2003, In-vehicle vibration study of child safety seats, *Ergonomics*, **46** (15), 1500-1512.

Griffin, M.J. 1990, *Handbook of human vibration* (London: Academic Press).

Grodin, M.A. and Glantz, L.H. 1994, *Children as research subjects: Science, ethics, and law* (Oxford: Oxford University Press).

Holmlund, P and Lunström, R. 1998, Mechanical impedance of the human body in the horizontal direction, *Journal of Sound and Vibration*, **215** (4), 801-812.

Holmlund, P. 1999, Absorbed power and mechanical impedance of the seated human measured within a real vehicle environment compared with single axis laboratory data, *Journal of Low Frequency Noise, Vibration and Active Control*, **8** (3), 97-110.

Holmlund, P., Lunström, R. and Lindberg, L. 2000, Mechanical impedance of the human body in vertical direction, *Applied Ergonomics*, **31**, 415-422.

Holmlund, P. and Lundström, R. 2001, Mechanical impedance of the sitting human body in single-axis compared to multi-axis whole-body vibration exposure, *Clinical Biomechanics*, **16** (Supl. 1), S101-S110.

International Organisation for Standardisation 1980, *ISO 5344:1980 Electrodynamic test equipment for generating vibration -- Methods of describing equipment characteristics* (Geneva: International Organisation for Standardisation).

International Organisation for Standardisation 1981, *ISO 5982 (1981): Vibration and shock – Mechanical driving point impedance of the human body* (Geneva: International Organisation for Standardisation).

International Organisation for Standardisation 1997, *ISO 2631-1 (E) Mechanical vibration and shock – evaluation of human exposure to whole-body vibration* (Geneva: International Organisation for Standardisation).

International Organisation for Standardisation 2001, *ISO 5982:2001 (E) Mechanical vibration and shock – range of idealised values to characterise seated-body biodynamic response under vertical vibration* (Geneva: International Organisation for Standardisation).

LMS International 1999, *LMS CADA-X Endurance Monitor Manual, Revision 3.5B* (Leuven: LMS International).

Maia, N.M.M. and Silva, J.M.M. 1997, *Theoretical and experimental modal analysis* (Taunton, Somerset: Research Studies Press Ltd.).

Mansfield, N.J. and Lundström, R. 1999, The apparent mass of the human body exposed to non-orthogonal horizontal vibration, *Journal of Biomechanics*, **32**, 1269-1278.

Mansfield, N.J. and Griffin, M.J. 2000, Non-linearities in apparent mass and transmissibility during exposure to whole-body vertical vibration, *Journal of Biomechanics*, **33**, 933-941.

Mansfield, N.J., Holmlund, P. and Lundström, R. 2001, Apparent mass and absorbed power during exposure to whole-body vibration and repeated shocks, *Journal of Sound and Vibration*, **248** (3), 427-440.

Mansfield, N.J. and Griffin, M.J. 2002, Effects of posture and vibration magnitude on apparent mass and pelvis rotation during exposure to whole-body vibration, *Journal of Sound and Vibration*, **253** (1), 93-107.

McConnell, K.G. 1995, *Vibration testing: theory and practice* (New York: John Wiley & Sons).

Medical Research Council, Natural Sciences and Engineering Research Council and Social Sciences and Humanities Research Council of Canada 1998, *Tri-council policy statement on ethical conduct for research involving humans* (Ottawa: Medical Research Council).

Miwa, T. 1975, Mechanical impedance of human body in various postures, *Industrial Health*, **13** (1), 1-22.

Paddan, G.S. and Griffin, M.J. 2002, Evaluation of whole-body vibration in vehicles, *Journal of Sound and Vibration*, **253** (1), 195-213.

Rakheja, S., Stiharu, I. and Boileau, P.E. 2002, Seated occupant apparent mass characteristics under automotive postures and vertical vibration, *Journal of Sound and Vibration*, **253** (1), 57-75.

Sandover, J. 1978, Modelling human responses to vibration, *Aviation, Space and Environmental Medicine*, **49** (1), 335-339.

Slonim, A.R. 1985, Comparative biodynamic response of two primate species to the same vibrational environment, *Aviation, Space and Environmental Medicine*, **56**, 945-955.

Smith, S.D. 1992, Impedance response characteristics of the primate *mucaca mulatta* exposed to seated whole-body g_z vibration, *Journal of Biomechanics*, **25**, 839-847.

Smith, S.D. and Kazarian, L.E. 1994, The effects of acceleration on the mechanical impedance response of a primate model exposed to sinusoidal vibration, *Annals of Biomedical Engineering*, **22**, 78-87.

Tilley, A.R. 1993, *The measure of man and woman* (New York: Henry Dreyfuss Associates).

Vogt, L.H., Coermann, R.R. and Fust, H.D. 1968, Mechanical impedance of the sitting human under sustained acceleration, *Aerospace Medicine*, **39** (7), 675-679.

Von Bekésy, G 1939, Über die empfindlichkeit des stehenden und sitzenden menschen gegen sinusförmige erschütterungen, *Akustische Zeitschrift*, **4**, 360-369.

Vykukal, H.C. 1968, Dynamic response of the human body to vibration when combined with various magnitudes of linear acceleration, *Aerospace Medicine*, **39**, 1163-1166.

Wei, L. and Griffin, J. 1998, Mathematical models for the apparent mass of the seated human body exposed to vertical vibration, *Journal of Sound and Vibration*, **212** (5), 855-874.

Wittmann, T.J. and Phillips, N.S. 1969, Human body nonlinearity and mechanical impedance analyses, *Journal of Biomechanics*, **2**, 281-288.

Seat	Mass (kg)	Internal Width (mm)	L ₁ (mm)	L ₂ (mm)	L ₁ +L ₂ (mm)	T (deg)	F (deg)
Britax Rock-A-Bye	2.5	240	270	450	720	43	85
Mothercare Rock 'n' Go	2.8	280	290	440	730	20	70

Table 1 Sitting posture parameter values for two stage 0&1 child seats.

Child	Age (months)	Mass (kg)	Height (cm)	Sex (M/F)
al	10.0	9.4	76.0	M
im	15.0	11.0	86.0	M
ja	13.0	11.4	80.0	M
ju	3.0	5.2	50.0	F
le	8.5	9.4	73.0	M
ma	7.0	8.0	66.0	F
mo	14.5	10.2	71.0	F
sa	23.0	12.4	85.0	F
Mean	11.8	9.6	73.4	-
Std.	6.1	2.2	11.7	-

Table 2) Test subject characteristics.

Phase	Tasks Performed and Information Obtained
Research objectives and test method (~4 minutes)	Parents were instructed regarding the research objectives and methods. A detailed verbal description of the safety features of the child testing facility was given. The type and level of acceleration signal used was stated as were the levels normally occurring in automobiles.
Reading and signing of the participation form (~2 minutes)	The parent or parents were asked to read, sign and date the participation form which repeated the main safety and test features.
Child anthropometric measurement (~2 minutes)	Supine length was measured on a table surface and weight was measured using a scale.
Play and familiarisation (~10 minutes)	A period of time was dedicated to play and familiarisation such that the child could become acquainted with, and comfortable in, the laboratory environment.
Seating and adjustment (~1 minute)	The child was placed in the rigid test seat by the parent and the belt straps were adjusted by the researcher. The cot mobile was activated and book reading was initiated.
Vibration testing (~8 minutes)	A complete test sequence consisted of a 2 minute exposure using the 1400mV signal followed by the saving of all time histories and transfer functions to disk, followed by the 2 minute 1800 mV signal and the saving of all 1800mV data. A maximum of two sequences were performed for any given child on a single day.

Table 3) Child vibration testing protocol.

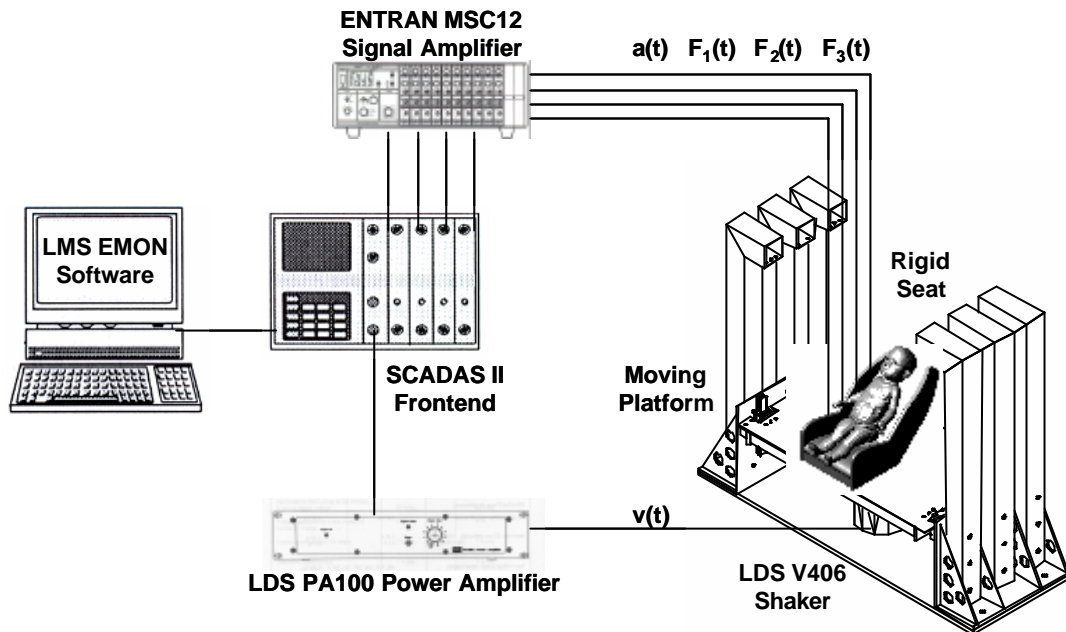

Figure 1) Schematic diagram of the child vibration testing facility.

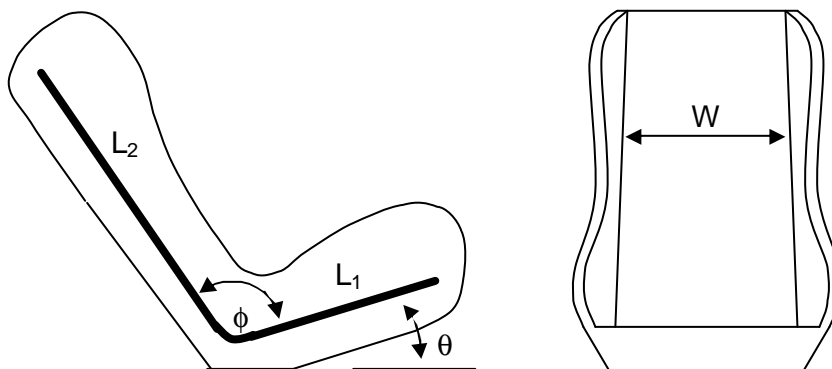

Figure 2) Parameters defining the sitting posture of stage 0&1 child seats.

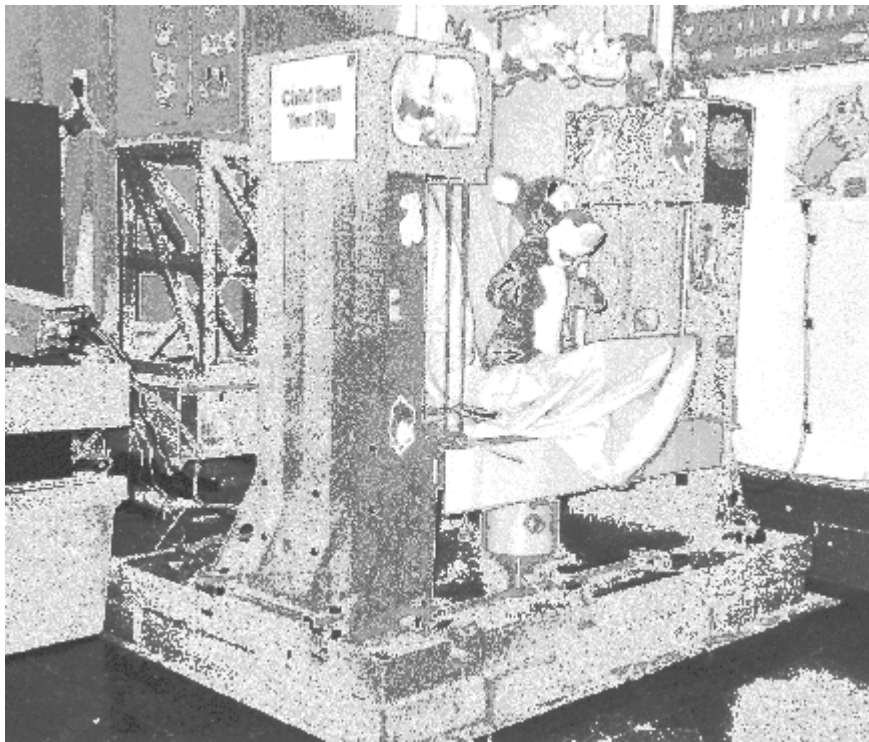

Figure 3) Child vibration testing facility.

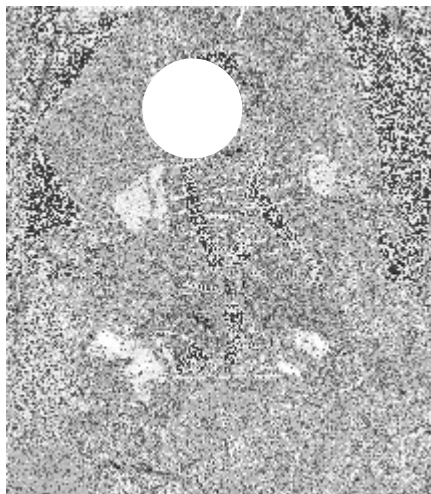

Figure 4) Example of small movements during vibration testing.

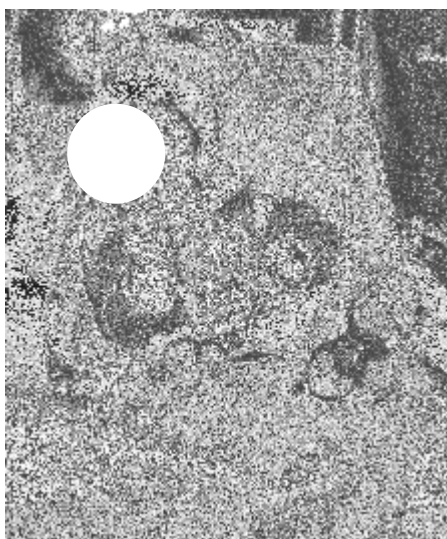

Figure 5) Example of large change of posture during vibration testing.

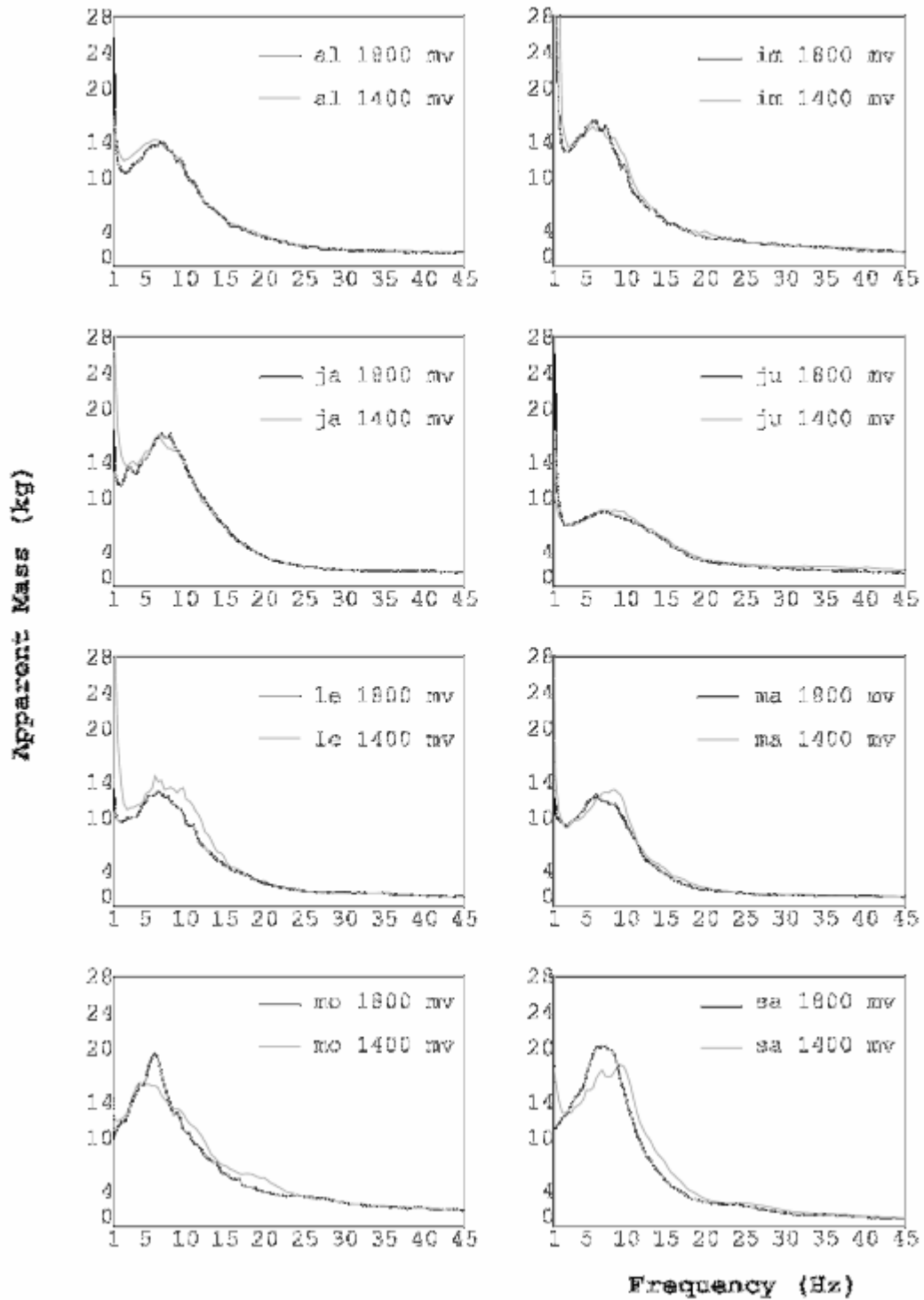

Figure 6) Apparent mass modulus functions for eight children tested at r.m.s. acceleration levels of 0.8 m/s^2 (1400mV) and 1.2 m/s^2 (1800 mV).

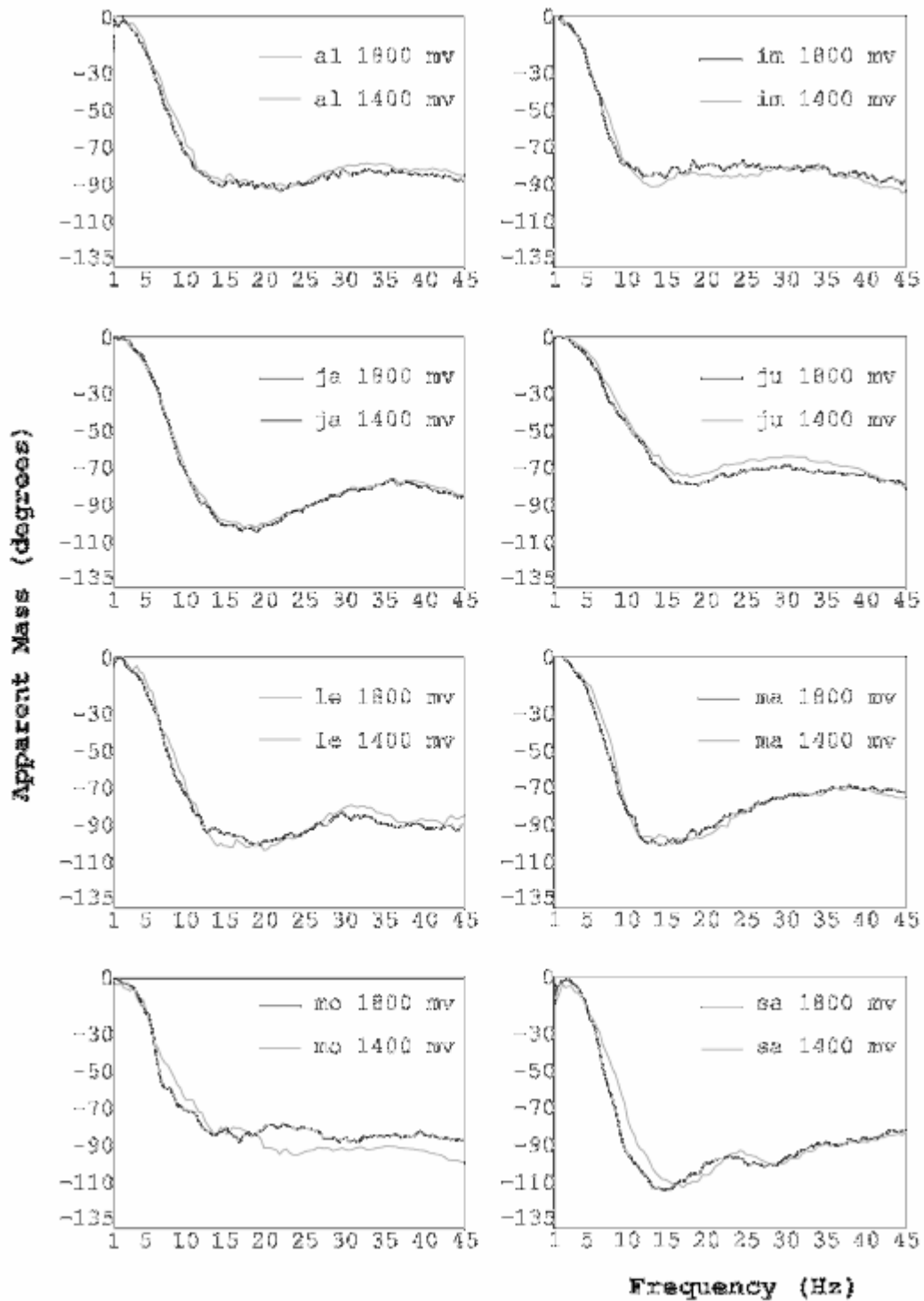

Figure 7) Apparent mass phase functions for eight children tested at r.m.s. acceleration levels of 0.8 m/s^2 (1400mV) and 1.2 m/s^2 (1800 mV).

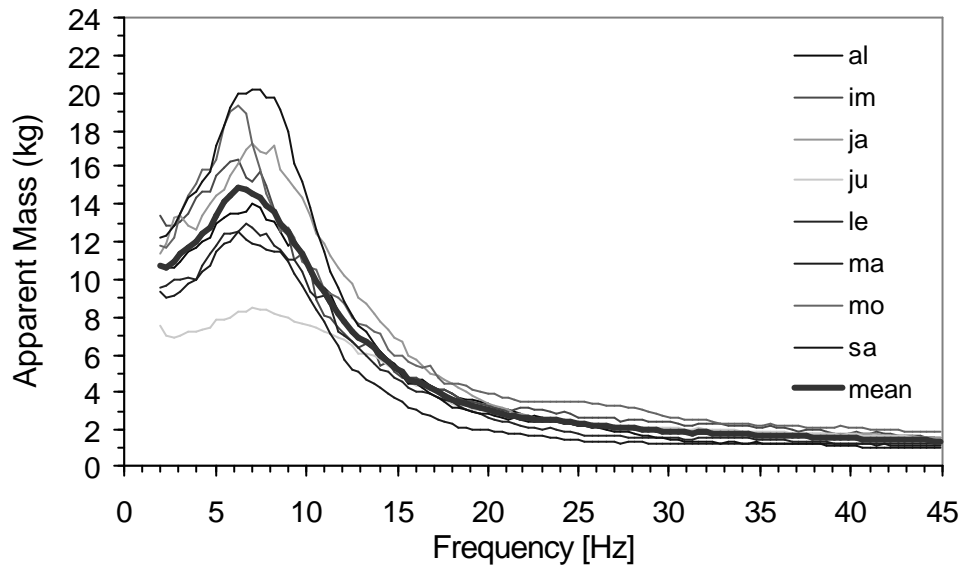

Figure 8) Individual and group mean apparent mass modulus for eight children.

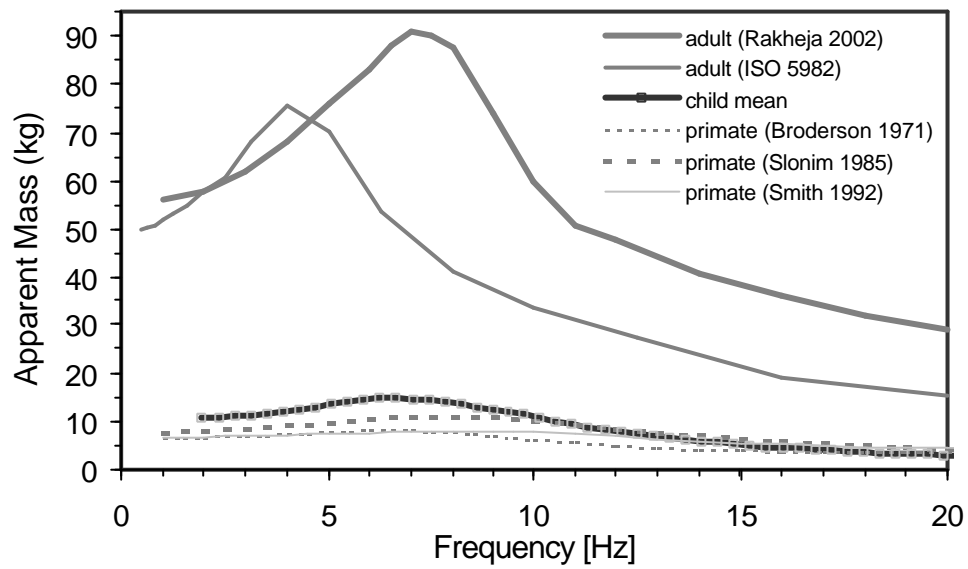

Figure 9) Comparison between the mean apparent mass modulus found for eight children and values reported for adults and small primates.

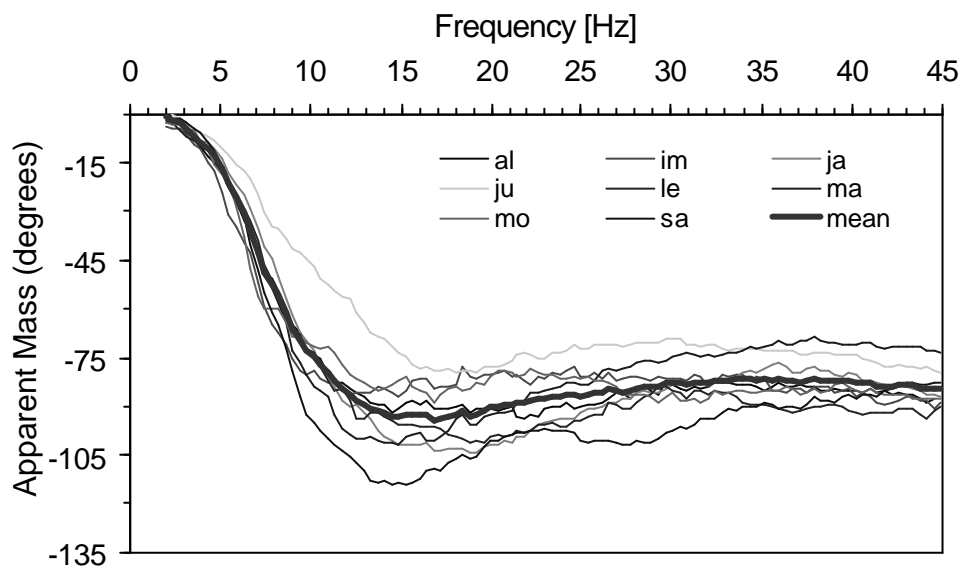

Figure 10) Individual and group mean apparent mass phase for eight children.

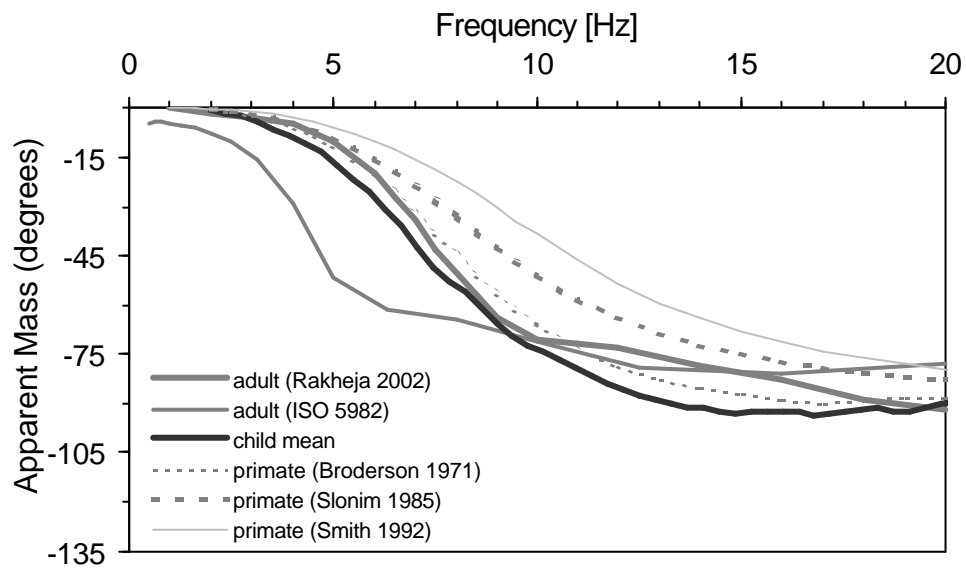

Figure 11) Comparison between the mean apparent mass phase found for eight children and values reported for adults and small primates.

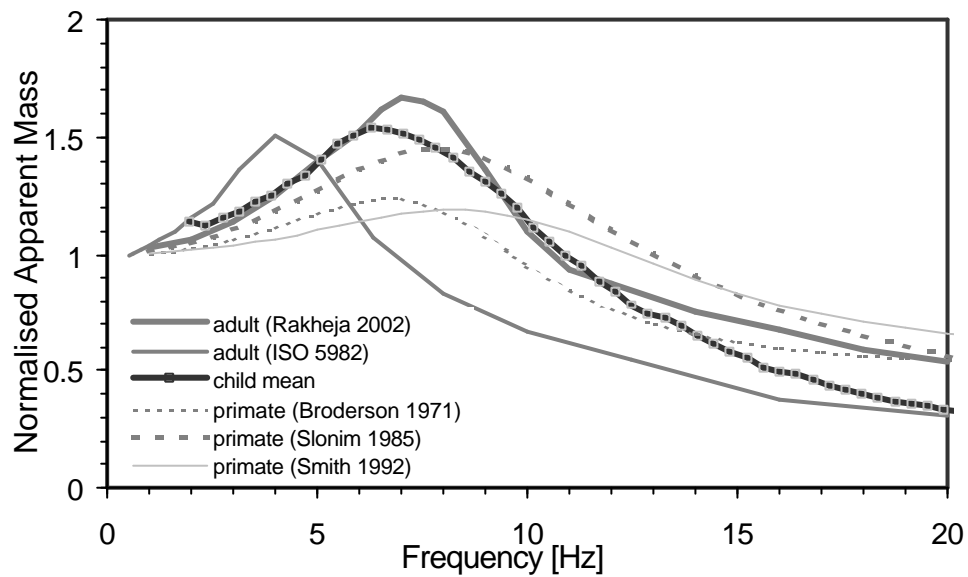

Figure 12) Comparison between the normalised mean apparent mass modulus for eight children and values reported for adults and small primates.